

**Please, read this manual
carefully before use!**

Owner's Manual



Electric chainsaw

KS CS1800-14

KS CS2200-16

KS CS2400-18

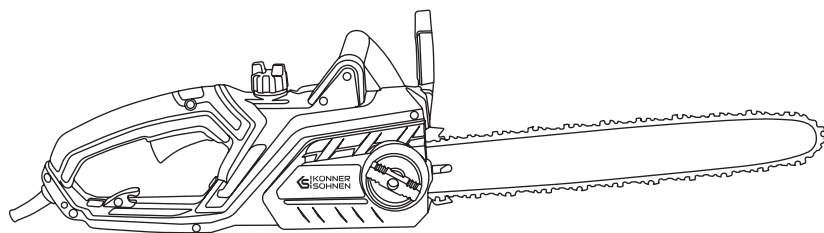



Thank you for opting for **Könner & Söhnen®** products. This manual contains a brief description of safety, setup and use. More information can be found on the official importer's website in the support section: **konner-sohnen.com/manuals**

You can also go to the support section and download the manual by scanning the QR code or on the website of the official importer of **Könner & Söhnen®** at **www.konner-sohnen.com**



*Please, read this manual
carefully before use!*

The manufacturer of **Könner & Söhnen®** products reserves the right to make changes that may not be reflected in this manual, namely:

- The manufacturer reserves the right to make changes in the product design, configuration and construction.
- The images and drawings in this manual are for reference only and may differ from the actual components and inscriptions on the products.

Contact information that you are free to use in case of any problems can be found at the end of this manual. All information in this manual is correct to the best of our knowledge and belief at the date of its publication. The current list of service centers can be found on the official importer's website at **www.konner-sohnen.com**



ATTENTION – DANGER!



Failure to follow the recommendations marked with this sign may lead to serious injury or death of the operator or third parties.



IMPORTANT!



Useful information while operating the machine.

IMPORTANT SAFETY INFORMATION

1



WARNING!



Packaging materials are not toys! Children must not play with plastic bags! Danger of suffocation!



ATTENTION – DANGER!



Read all instructions failure to follow all instructions listed below may result in electric shock, fire and /or serious injury.

WORK AREA

- Keep the work area clean and well lit. Cluttered and dark areas invite accidents.
- Do not operate power tools in explosive atmospheres, such as in the presence of flammable liquids, gases or dust. Power tools create sparks, which may ignite the dust or fumes.
- Keep children or unauthorized individuals away from the work area, while working with power tools. Distractions can cause you to lose control.

ELECTRICAL SAFETY



WARNING!



Always check that the power supply corresponds to the voltage on the rating plate.

- Avoid body contact with earthed or grounded surfaces such as pipes, radiators, ranges and refrigerators. There is an increased risk of electric shock if your body is earthed or grounded surfaces.

- Do not store or use power tools in wet conditions (rain, snow). Water entering a power tool will increase the risk of electric shock.
- Never use the cord to carry the tool, and do not pull the cord when disconnecting the power tool. Keep the cord away from heat, oil and sharp edges or moving parts. Damaged or entangled cords increase the risk of electric shock.
- When operating a power tool outdoors, use an extension cord suitable for outdoor use.

PERSONAL SAFETY

- Do not operate tool when you are tired or under the influence of drugs, alcohol or medication.
- Use safety equipment. Always wear eye protection. Safety equipment such as dust mask, non-skid safety shoes, hard hat, or hearing protection will reduce personal injuries.
- Avoid accidental starting. Ensure the switch is in the off position before plugging in.
- Do not overreach. Keep proper footing and balance at all times. This enables better control of the power tool in unexpected situations.
- Do not wear loose clothing or jewellery; Keep your hair, clothing and gloves away from moving parts. Loose clothes, jewellery or long hair can be caught in moving parts.

POWER TOOL USE AND CARE

- Do not use the power tool if the switch does not turn it on and off. Any power tool that cannot be controlled with the switch is dangerous and must be repaired.
- Disconnect the plug from the power source before making any adjustments, changing accessories, or storing power tools.
- Store idle power tools out of the reach of children.
- Maintain power tools.
- Keep cutting tools sharp and clean.

CHAIN SAW SAFETY WARNINGS

2

- Before you start the chain saw, make sure the saw chain is not contacting anything.
- Hold the power tool by insulated gripping surfaces only.
- Always hold the chain saw with your right hand on the rear handle and your left hand on the front handle.
- Wear safety glasses and hearing protection. It is advisable to wear protective, close-fitting footwear and clothing.
- Do not operate a chain saw on a tree. Operation of a chain saw while up in a tree may result in personal injury.
- Use the power tool on a level surface. Do not use it while standing on a ladder or on a slippery surface.
- Use extreme caution when cutting brush and saplings. Thin material can get into the chainsaw chain, potentially causing imbalance.
- Carry the chain saw by the front handle with the chain saw switched off and away from your body. When transporting or storing the chain saw, always fit the guide bar cover.
- Follow instructions for lubricating, chain tensioning and changing accessories. Improperly tensioned or lubricated chain may either break or increase the chance for kickback.
- Keep handles dry, clean, and free from oil and grease.
- Use the saw for cutting wood only. For example: do not use chain saw for cutting plastic, or non-wood building materials.

CAUSES AND OPERATOR PREVENTION OF KICKBACK

3

KICKBACK

Kickback may occur when the nose or tip of the guide bar touches an object, or when the woodcloses in and pinches the saw chain in the cut. Such dangerous kickbacks can largely be avoided by working quietly and with forethought in the following manner:

- While sawing, always watch the guide-bar nose
- Never attempt to cut with the nose of the guide bar.
- Take care when cutting thin and springy branches.

Particular care must be taken when inserting the into an already started cut.

- Maintain a firm grip, with both hands on the saw and position your body and arm to allow you to resist kickback forces. Kickback forces can be controlled by the operator, if proper precautions are taken.
- Do not overreach and do not cut above shoulder height. This helps prevent unintended tip contact and enables better control of the chain saw in unexpected situations.
- Only use replacement bars and chains specified by the manufacturer. Incorrect replacement bars and chains may cause chain breakage.

PULL-FORWARD

If the bumper spikes are not properly secured on the wood during sawing with the lower part of the bar, the chain may become jammed or get caught on a hard object in the wood, pulling the saw forward. To minimize these risks it is thus important to saw with the spiked stop against the timber whenever possible.

SAFETY INSTRUCTIONS

4

Use the chain saw only to saw wood or objects made of wood!!!! Any other types of use are dangerous! The manufacturer is not liable for damage caused by improper or incorrect usage.











SAFETY INSTRUCTIONS AND ACCIDENT PREVENTION

- Switch the chainsaw off before releasing the chain brake.
- The saw must not be touching anything when it starts up.
- Never expose the electric chainsaw to rain or bad weather
- Always set the serrated stop before you start to saw.
- Never use the chainsaw when standing on a ladder, in a tree or in any other instable places. Do not saw with one hand.
- The power cable must always be behind the saw operator.
- The power cable must always lead away from the rear of the chainsaw.
- Chainsaws used outdoors must be connected up to an earth-leakage circuit-breaker.
- Do not overload your power tools. They run best and safest within given range of capacity.
- Always set the serrated stop before cross-cutting. Only then switch on the chainsaw and start sawing into the wood. Pull the chainsaw upwards at the rear and lead the direction with the front grip. Use the serrated stop as a fulcrum. To reposition for further cutting, pull the saw back a little, position the serrated stop further down the cut and pull up the rear grip.
- Pull the saw out of the wood only when the saw chain is running.
- Pay extra attention when cutting splintered wood. Sawed off pieces of wood may be catapulted in any direction (risk of injury!)
- Do not cut with the tip of the guide bar.
- Pay special attention to branches under tension. Do not cut through freely suspended branches from underneath.
- Never stand on the trunk when lopping off branches.
- Always stand to the side of the tree being felled.
- When the tree is being felled, watch out for falling branches when stepping back.
- On slopes the saw operator should stand to the upper or left or right side the trunk or lying tree, never to the bottom side.
- Watch out for trunks rolling towards you.
- The power saw is likely to recoil if the tip of the guide bar (especially the top quarter) accidentally touches wood or any other solid objects. In this case the saw will move uncontrolled (risk of injury!).

- Always pull the plug from the socket outlet before attempting to check or adjust the chain or to correct some fault and whenever moving one workplace to another.
- Never switch on the chain saw unless you have a firm hold of the tool. a secure footing and are sure that the guide bar and saw chain are not touching anything.
- Never saw above shoulder height, while standing on a ladder or in a tree or in any other insecure position.
- When sawing timber that has split, take particular care that no small pieces of wood are broken off and thrown by the saw chain.
- During breaks, the saw should be laid down in such a way that there is no risk of injury to anyone from the saw chain.

SYMBOLS

5

	Read all safety warnings and all instructions. Failure to follow the warnings and instructions may result in electric shock, fire and/or serious injury.
	Wear personal protective equipment. Basically, wear protective goggles or, even better, face protection, ear protection, safety helmet, cut-protection working clothes, cut-protection safety boots with anti-slip soles.
	CAUTION: Kickback!
	Beware of falling objects. Keep bystanders away.
	Do not cut with the tip of guide.
	Hold the saw with both hands while working! One-handed use is extremely hazardous!
	Keep the equipment away from nearby people. Keep bystanders away.
	Remove the plug from the socket or mains before carrying out any adjustments, servicing or maintenance or if the cable is damaged or cut.
	Do not use the machine in the rain or leave it outdoors when it is raining.
	Information of the acoustic power level Lwa in dB.
	Protection class II.

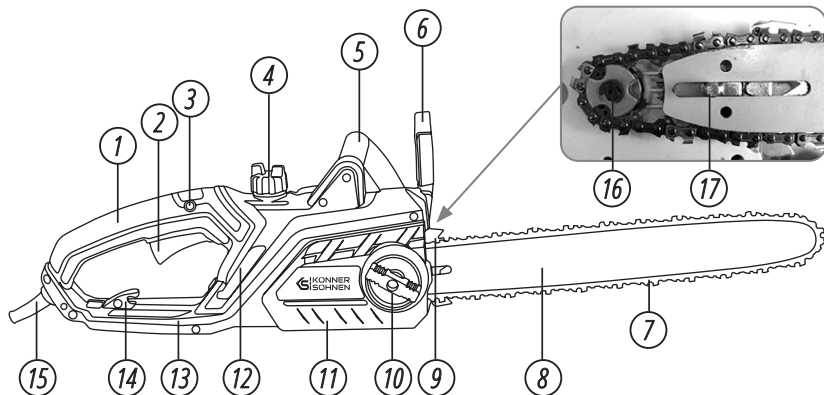

- 1. Rear grip
- 2. ON/OFF switch
- 3. Safety lock- button
- 4. ON/OFF switch
- 5. Front grip
- 6. Front finger guard/Chain break
- 7. Saw chain
- 8. Guide bar
- 9. Serrated stop
- 10. Toolless chain tension system (clamping and adjustment)
- 11. Guide bar cover
- 12. Oil gauge
- 13. Rear finger guard
- 14. Cable hook
- 15. Power cable
- 16. Chain wheel
- 17. Guide bolt



IMPORTANT!



Manufacturer reserves the right to make changes and/or improvements in design, components set and technical attributes without notice and without incurring obligation. The pictures in this manual are schematical and may not match the parameters of original product.

Model	KS CS1800-14	KS CS2200-16	KS CS2400-18
Operating voltage/Frequency	230V/50 Hz		
Rated power	1800 W	2200 W	2400 W
Chain length	14" (35 cm)	16" (40 cm)	18" (45 cm)
Chain pitch	3/8"	3/8"	3/8"
Chain gauge	050"	050"	050"
Chain speed	15 m/s	14 m/s	13 m/s
Oil tank capacity	280 ml	140 ml	190 ml
Double safety brake	+	+	+
Chain tensioning without a tool	+	+	+
Soft start	-	+	+
Overload protection	-	+	+
Gross dimensions (L×W×H)	500×285×200 mm	545×225×255 mm	510×265×200 mm
Gross/Net weight	5.4/4.7 kg	5.9/5.2kg	6.3/5.7 kg

TRANSPORTING THE CHAINSAW

8

Before transporting the chainsaw, always remove the plug from the power socket and slide the chain guard over the rail and chain. If several cuts are to be performed with the chain saw, the saw must be switched off between cuts.

BEFORE STARTING UP

9

- The voltage and current supply must comply with the ratings on the type plate.
- Before commencing work, always check that the chainsaw works properly and is safe to operate.
- Check also that the chain lubrication and the oil gauge are in good working order. When the oil lever is approx. 5 mm from the bottom mark, you must top up with oil. When the oil level is higher you can work without worry.
- Check the chain tension and retention, if necessary .
- Make sure the chain brake is working properly .

MAINTENANCE AND CLEANING GUIDELINES

10

For maintenance and cleaning tasks, always ensure the motor is switched off and the power plug is disconnected to prevent injury. Any service not specified in this manual should be performed by an authorized service center. Use only genuine replacement parts.

Allow the machine to cool down completely before beginning any maintenance or cleaning to avoid the risk of burns.

CLEANING PROCEDURES



ATTENTION – DANGER!



Always pull the plug out of the power socket before doing any work on the chainsaw!

- After each use, clean the machine thoroughly to prolong its lifespan and prevent accidents.
- Keep the handles free from oil, grease, or fuel. If necessary, wipe the handles with a damp cloth using soap, avoid using solvents or gasoline for cleaning purposes.
- Clean the saw chain after each use with a paintbrush or cloth. Do not use any liquids to clean the chain. Apply a light coating of chain oil after cleaning.
- Remove the chain wheel cover for cleaning to ensure this area is also maintained.
- Clean the chain bar (Guide).
- Use a paintbrush or dry cloth to clean the ventilation slots and machine surfaces. Refrain from using liquids for this purpose.
- Make sure to clean the oil passages of the chain bar to ensure oiling of the saw chain during operation.
- Do not modify the chain saw, otherwise your warranty will be invalid.

MAINTENANCE SCHEDULE

Follow a regular maintenance schedule as outlined in the following table to extend the life of your saw. Regular upkeep ensures optimal cutting performance and helps prevent accidents.

MAINTENANCE INTERVAL TABLE

Machine part	Action	Before every use	After 10 hours of operation	After every use
Components of the chain brake	Check, replace if required	✓		
Sprocket chain wheel (F 24)	Check, replace if required	✓		
Saw chain (F 5)	Check oil, regrind or re- place if required	✓		
	Clean and oil			✓
Guide bar (F 4)	Check, clean and oil	✓		✓
	Turn around		✓	
Oil automatic system	Check and, where appropriate, clean oil outflow duct	✓		

MOUNTING THE CHAIN

11



IMPORTANT!



The front finger guard (6) must always be in the top (vertical) position.

The guide bar and saw chain are supplied separately. To assemble, first unscrew the lock nut (b) and remove the guide bar cover (11). The guide bolt (17) must be in the centre of the guide. If necessary, adjust the chain tensioning with the chain wheel (a).

Before assembling the guide bar with the saw chain, check the cutting direction of the teeth!

The running direction is marked determine with an arrow on the cover (11).

To the direction of cut, it may be necessary to turn over the saw chain (7). Hold the guide bar (8) vertically with the tip pointing upwards and put on the saw chain (7), beginning at the tip of the bar.

Then assemble the guide bar with the saw chain as follows:

- Place the guide bar with the saw chain on the chain wheel (16) and guide bolt (17).
- Place the saw chain round the chain wheel (16) and make sure it is correctly mounted .
- Place the cover (11) on top and tighten gently with the lock nut (b). Now the saw chain has to be correctly tensioned.

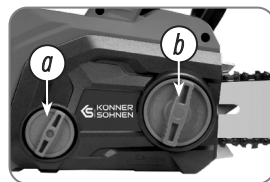
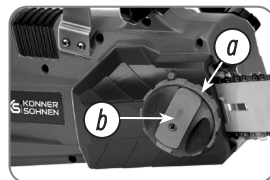

**a) Chain tensioning nut
b) Cover tightening nut**

STARTING UP A NEW SAW CHAIN

In the case of a new chain, the tensioning force decreases after some time. Therefore, you have to re-tension the chain after the first 5 cuts and no later than after 10 minutes' sawing time.



ATTENTION – DANGER!



Never attach a new chain to a worn drive pinion or place onto a damaged or worn chain bar. The chain could break, potentially leading to serious injury.

TENSIONING THE SAW CHAIN



ATTENTION – DANGER!



Before checking and adjusting the chain tension, never forget to unplug the tool.



WARNING!



Always pull the plug out of the power socket before doing any work on the chainsaw!



For user safety and to minimize wear or damage to the chain, regular chain tension checks are crucial. It's advisable to assess and adjust the chain tension before beginning work and then at roughly 10-minute intervals during use. Chains, particularly new ones, are prone to slight expansion when heated from use.

If the chain has been tightened while hot, loosen it after use. Failing to do so may damage the guide bar or engine due to excessive tightness as the chain cools and contracts. Both chain tension and lubrication are vital for the longevity of the chain.

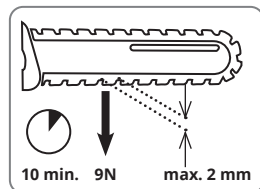
A properly tensioned chain should not droop on the underside of the guide bar and should still be rotatable by hand with a glove on. A tensioned saw chain, when pulled with a force of approximately 9 N (1 kg), should not leave a gap larger than 2 mm from the guide bar.



To adjust the chain tension, follow these steps:

1. Release the chain brake by ensuring the chain brake lever (6) is pulled back towards the front handle (5).
2. Loosen the fastening bolt (b) ().
3. For increasing chain tension, turn the chain quick-tensioning screw (a) clockwise. To decrease tension, turn it counterclockwise.
4. Secure the fastening bolt (b) once more ().



NOTE



With a new saw chain, re-tensioning is necessary after approximately five cutting operations.

SHARPENING THE SAW CHAIN

12



ATTENTION – DANGER!



A properly sharpened saw chain is crucial to minimize kickback danger. Always wear cut-protection gloves when handling the chain or chain bar.



NOTE



A sharp chain provides efficient cutting, slicing through wood easily. A blunt chain requires a strong pressure on the saw, which may cause the engine overload.

The chain's cutting parts include a cutting tooth and a depth gauge. The vertical distance between these components defines the cutting depth. Keep in mind the following specifications when sharpening the cutting teeth:

- Top-plate cutting angle (30°)
- Side-plate angle (85°)
- Depth gauge setting (0.65 mm)



ATTENTION – DANGER!



Deviating from the specified cutting geometry increases kickback risk.

Sharpening the saw chain requires expertise and specific tools to maintain correct angles and depth. Follow the instructions for sharpening chain. For those inexperienced with chainsaw maintenance, it's advisable to have the chain sharpened or replaced by a professional.

1. Turn off the saw and disconnect it from the power supply.
2. Use a 4.0 mm round file for sharpening.



WARNING!



Using other diameters can damage the chain and increase operational risks!

3. Always file from the inside out, guiding the file from the inside of the tooth outward and lifting the file on the return stroke.
4. Start by sharpening the teeth on one side, then turn the saw to sharpen the other side.
5. Post-sharpening, all cutting elements should be uniform in length.
6. Every third sharpening, check and file the depth gauge to maintain the correct setting of 0.65 mm below the cutting tooth, rounding off the front edge slightly after adjustment.

CHAIN LUBRICATION

13

To prevent excessive wear, the saw chain and guide bar must be evenly lubricated during operation. Lubrication is automatic. Never work without chain lubrication. It is therefore important to check both chain lubrication and the oil gauge every use. Never use the saw when the oil level is below the "Min." mark. (about 5 ml of oil l sleft). Top up with oil until the oil window is full.

CHECKING THE AUTOMATIC

14

Before work, check the automatic chain lubrication and oil gauge. Switch on the chain saw and hold it above the ground. Be careful not to allow to touch the ground. For safety reasons it is best to keep a clearance of at least 20 cm. If you now see growing traces of oil, the chain lubrication system is working correctly. If no oil trace can be seen clean the oil passages or turn the chainsaw to our Service-Center.

CHAIN LUBRICANTS

15

The service life depends to a large extent on the quality of the lubricant used. Old oil must not be used! To lubricate the cutting part of the saw, it is necessary to use only special adhesive oil for saw chains. Adhesive oil has increased adhesion to metal and lubricates not only the upper part of the saw bar but also the lower part.

GUIDE BAR AND WHEEL

16

The guide bar (8) is subjected to especially severe wear and tear at the nose and the bottom. To avoid one-sided wear and tear, turn the guide bar over every time when you sharpen the chain. The chain wheel (16) is subjected to especially high wear and tear as well. If you notice deep wear marks on the teeth, the chain wheel must be replaced. A worn chain wheel curtails the service life of the saw chain.

CHAIN GUARD

17

The chain guard must be clipped as soon as the sawing work has been completed and whenever the chainsaw has to be transported.

CHAIN BRAKE

18

In the event of kick-back, the chain brake (6) will be actuated via the front finger guard. The front finger guard is pushed forwards by the back of the hand and this causes the chain brake to stop the chain saw, or rather the motor, within 0.15 s.

RELEASING THE CHAIN BRAKE

In order to use the chainsaw again, you need to release the chain brake. Then push the front finger guard (6) back into the vertical position until it locks in place. Now, the chain brake is released.

INSTRUCTIONS FOR USE

19

If the chainsaw does not run, the chain brake must be released at the front finger guard (6).

- Do not use the saw above shoulder height.
- Only use the saw for working wood.
- Never start sawing before the machine is running at full speed.
- Always make a new cut. Never use a previous cut to proceed sawing.

SWITCHING ON AND OFF

20

Switch on the chainsaw only when chain bar, saw chain and sprocket chain wheel covering are correctly assembled. Ensure the voltage of the mains connection agrees with the label on the device. Make sure before you start that the electric chain saw is not touching anything

Only use extension cord suitable for outdoor use. The cross section of the cable must be at least 1,5 mm². Extension cord longer than 30 m will reduce the performance of the chainsaw.

Hold the electric chainsaw firmly with both hands, with the right hand on the rear grip and the left hand on the front handle. The thumb and fingers should securely cover the handles.

To turn on, press the locking button with your thumb and then press the ON/OFF switch with your index finger, the electric saw turns on.

Release either the ON/OFF switch (2).

The release of ON/OFF switch results the stop of the chainsaw within 1sec., and heavy sparking. This is normal and safe for the proper operation of the chainsaw. After working with the chainsaw, you should always clean the saw chain and guide bar and replace the chain guard.

OPERATION - TIPS ON CHAIN SAW USE

21

If possible, always use a saw horse (see Fig. M in Annex).

You have better control when you saw with the bottom side of the chain bar (with pulling saw chain) and not to with the top side of the chain bar (with pushing saw chain).

The saw chain must not contact either the ground or another object during sawing through or after sawing completion.

Make sure that the saw chain does not become jammed in the wood. Do not let the tree trunk break or split off.

Consider also the precautions against kick-back (see notes on safety).

For sawing work on hillsides, always stand in the area above the log.

To keep total control while sawing through, reduce the pressure at the end of the cut without loosening your grip on the handles of the electric chain saw. Make sure the saw chain does not touch the ground. After finishing the cut, wait until the electric chain saw comes to a halt before removing it. Always shut off the engine of the electric chain saw before moving between trees.

If the saw chain jams, do not attempt to pull the electric chainsaw out with force. There is a risk of injury. Switch off the motor and use a lever or wedge to release the electric chainsaw.

FELLING TREES

A lot of experience is required in felling trees. Only cut down trees when you can handle the electric chain saw safely.

For safety reasons, we advise inexperienced users not to knock down trunks with a guid bar smaller than the diameter of the trunk.

Ensure that no people or animals are in the field of action. The safety distance between the tree to be felled and the nearest-located workplace must be 2 ½ tree lengths.

Pay attention to the direction of fall:

The user must be able to safely move around the felled tree, easily saw the tree and remove the branches. Avoid getting the cut tree caught on another tree. Pay attention to the natural direction of fall, which depends on the characteristics of the inclination and curvature of the tree, the direction of the wind and the number of branches.

For sawing work on hillsides, the user of the chainsaw should stay in the area above the tree that is to be felled, as the tree will probably roll down or slide off downhill after being felled.

Small trees, with a diameter of 15- 18 cm, can usually be sawn off with one cut.

In case of trees with a larger diameter, a notched cut and a back cut must be implemented (see diagram).

Do not fell any trees when a strong or changing wind is blowing, if the danger of property damage exists or if the tree could fall on electric wires.

When felling trees, ensure that no other persons are exposed to hazards, that no supply lines are hit, and that no property damage is caused. If a tree should come into contact with a supply line, the utility company must be informed immediately.



WARNING!



Felling trees is dangerous and requires practice!

PREPARATION OF THE WORKING AREA NEAR THE TRUNK

1. Branch removal: remove overhanging branches. When removing branches, never work above shoulder level.

2. Escape area:

Remove the undergrowth around the tree to ensure an easy escape. The escape area (see Fig. O(1) in Annex) should be around 45° either side behind the planned felling direction (see Fig. O(2) in Annex).

3. Cutting notch (see Fig. P (a), R in Annex):

Make a felling notch in the direction in which you wish the tree to fall. Start with the bottom, horizontal cut. The cut depth should be around 1/3 of the trunk diameter. Now make a slanted saw cut from above at an angle of roughly 45° to meet exactly with the bottom saw cut.

4. Felling cut (see Fig. P (b), R in Annex):

Cut horizontally towards the felling notch. The back cut must run horizontally 5 cm above the horizontal notched cut. Leave approx. 1/10 of diameter uncut. This is the hinge.

The hinge prevents the tree from turning and falling in the wrong direction. Do not cut through the hinge.

5. If the saw begins to pinch, insert a wedge to open the cut. Use wooden, plastic or aluminium wedges to open the cut and fell the tree (see Fig. Q in Annex).

6. After carrying out of the felling cut, the tree falls by itself or with the aid of the felling wedges or fall lifter (see Fig. Q in Annex).

As soon as the tree begins to fall, pull out the saw, stop the motor, and leave the work place using the escape path (see Fig. O(1) in Annex).

Pay attention to falling branches and do not stumble.

Limbing

Many accidents occur during the removal of branches. Never cut tree limbs when you are standing on the log. Keep the spring-back area in mind if branches are under tension.

- Do not remove support branches until after the sawing off.
- Branches under tension must be sawed from below to above, in order to prevent jamming of the chainsaw (see Fig. N in Annex).
- When working on thicker branches, use the same technique as when you are sawing up a felled trunk. Work to the left of the log and as near as possible to the chainsaw. As far as possible, the weight of the saw should rest on the log.
- Change position to saw off branches on the other side of the trunk.
- Branches sticking out are cut off separately.
- Cut off smaller branches, as shown in Figure, in one go.

BUCKING

This refers to sawing up a felled tree trunk into smaller sections.

Ensure that the saw chain does not come in contact with the ground during sawing.

Make sure you have a secure stance and, in the case of sloping ground, stand above the log.

Ensure that you have secure footing and balance your body weight evenly on both feet. If possible, the trunk should be protected and supported by branches, logs or wedges. Follow the simple instructions for easy sawing.

1. Log is lying on the ground: Saw through the log completely from above and ensure at the end of the cut not to contact the ground (see Fig. J in Annex).

If you can turn the tree trunk, saw two-thirds of the way through it. Then turn the trunk around and saw the rest of the way through from above.

2. Log is supported at one end (see Fig. K in Annex):

Start sawing from the bottom and work your way up (with the upper edge of the bar) a third of the way into the diameter of the trunk to prevent splitting. Then saw from the top downwards with the lower edge of the bar towards the first cut to prevent the bar from becoming jammed in the wood.

3. The Log is support at both ends (see Fig. L in Annex):

Start from the top and work down (with the lower edge of the bar) to a third of the diameter of the trunk. Then saw from underneath with the upper edge of the bar until the two cuts meet.

DISPOSAL

22



Do not throw it in the domestic waste but dispose of it in an environmentally safe way, in accordance with current law.

STORAGE

23

- Protect it from exposure to direct sunlight. Keep it in the dark, if possible.
- Don't keep it in plastic bags to avoid humidity build-up.

WARRANTY SERVICE TERMS

24

The international manufacturer warranty is 1 year. The warranty period starts from the date of purchase. In cases when warranty period is longer than 1 year according to local legislation please contact your local dealer. The Seller which sells the product is responsible for granting the warranty. Please contact the Seller for warranty. Within the warranty period, if the product fails because of defects in the production process, it will be exchanged on the same product or repaired.

All faults caused by the manufacturer during the warranty period will be eliminated free of charge. Warranty repair is carried out only if you have a fully completed warranty card, the Buyer's signature of acceptance of the warranty terms, as well as a document supporting the purchase (cash receipt, sales slip or invoice). In the absence thereof, as well as in the event of errors or corrections not authenticated by the seller's seal or illegible inscriptions in the warranty card or tear-off coupon, no warranty repair is carried out, no objections to quality are accepted and the warranty card is withdrawn by the service center as invalid. The device is accepted for repair clean and full.

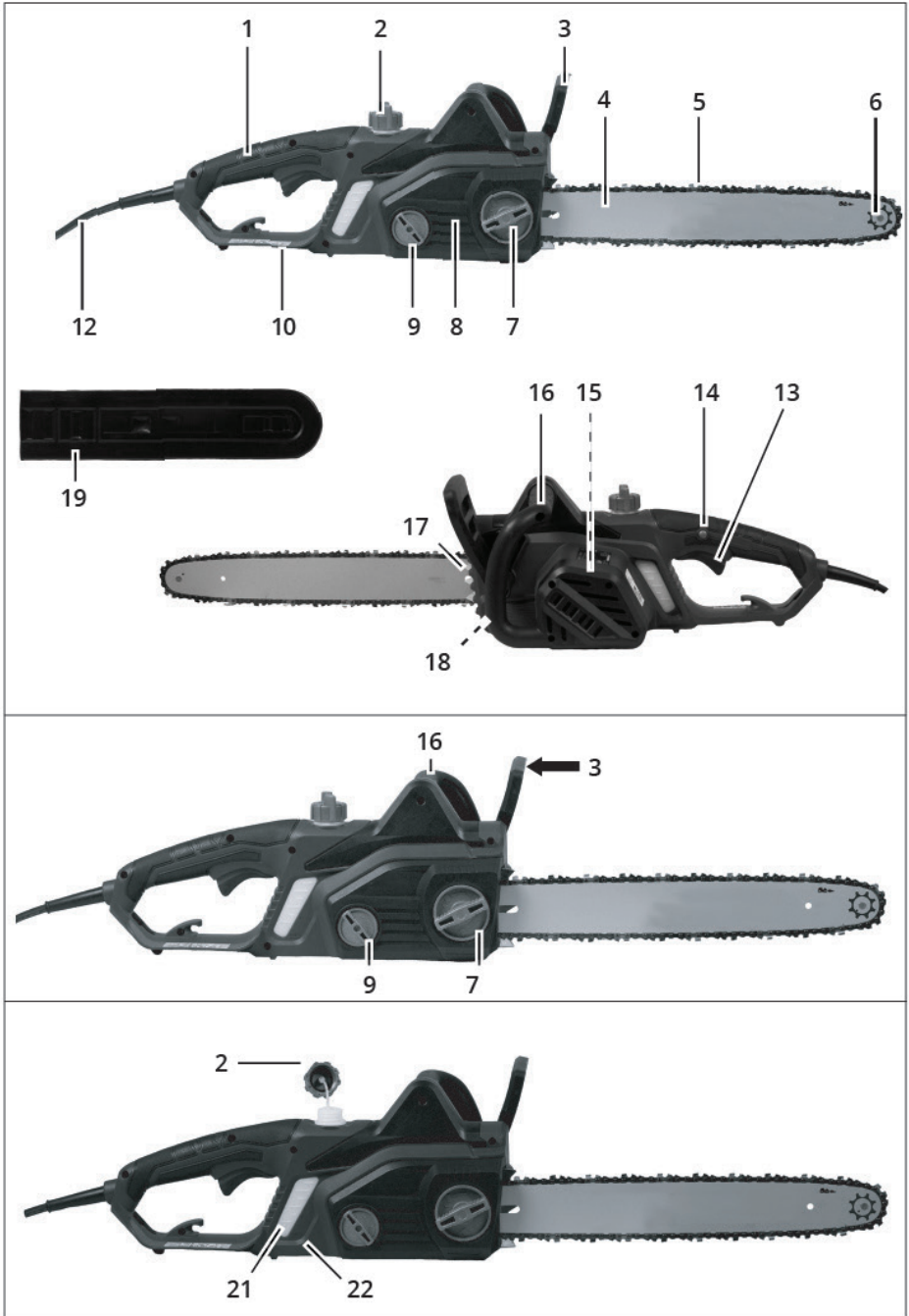

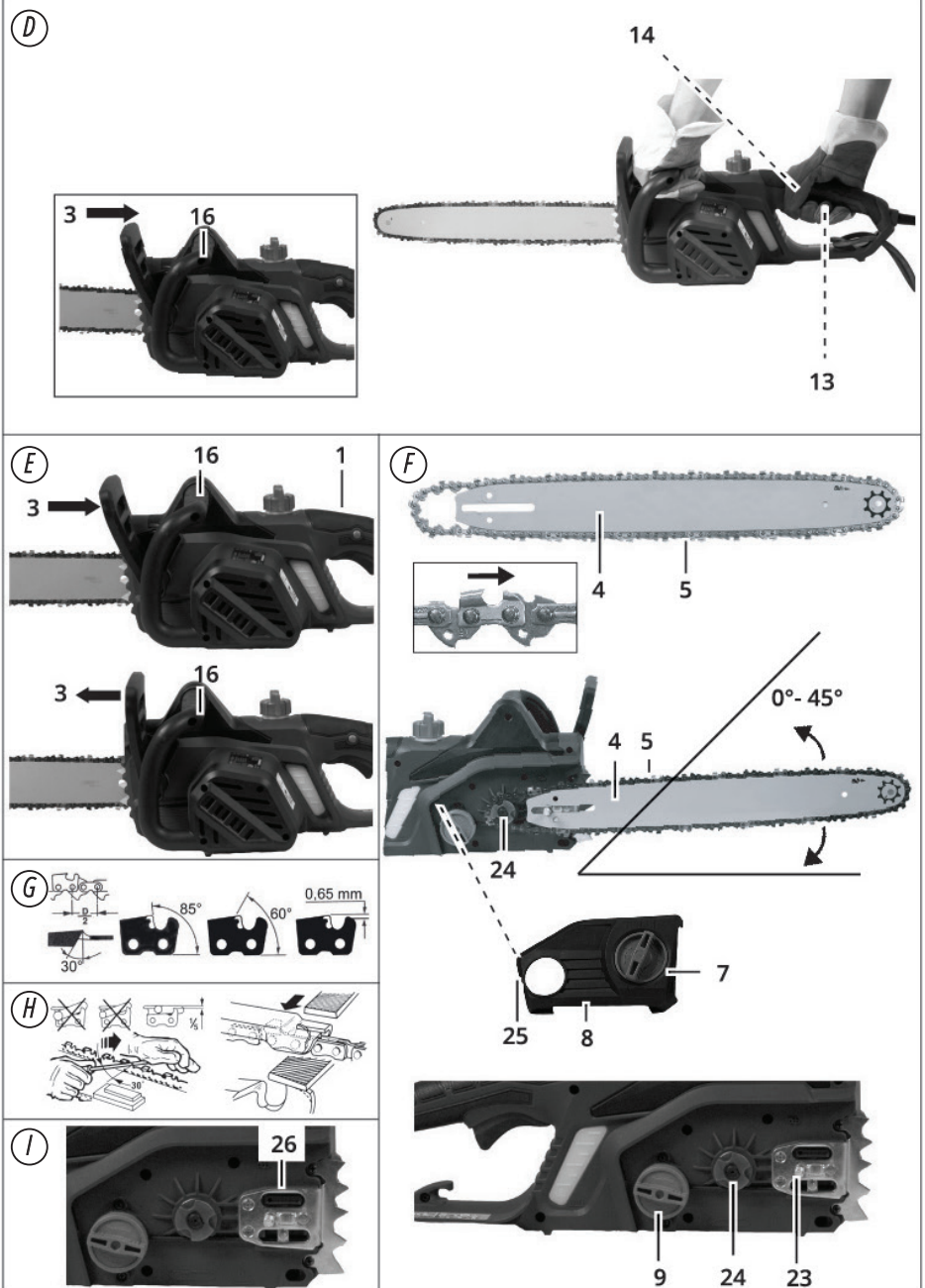

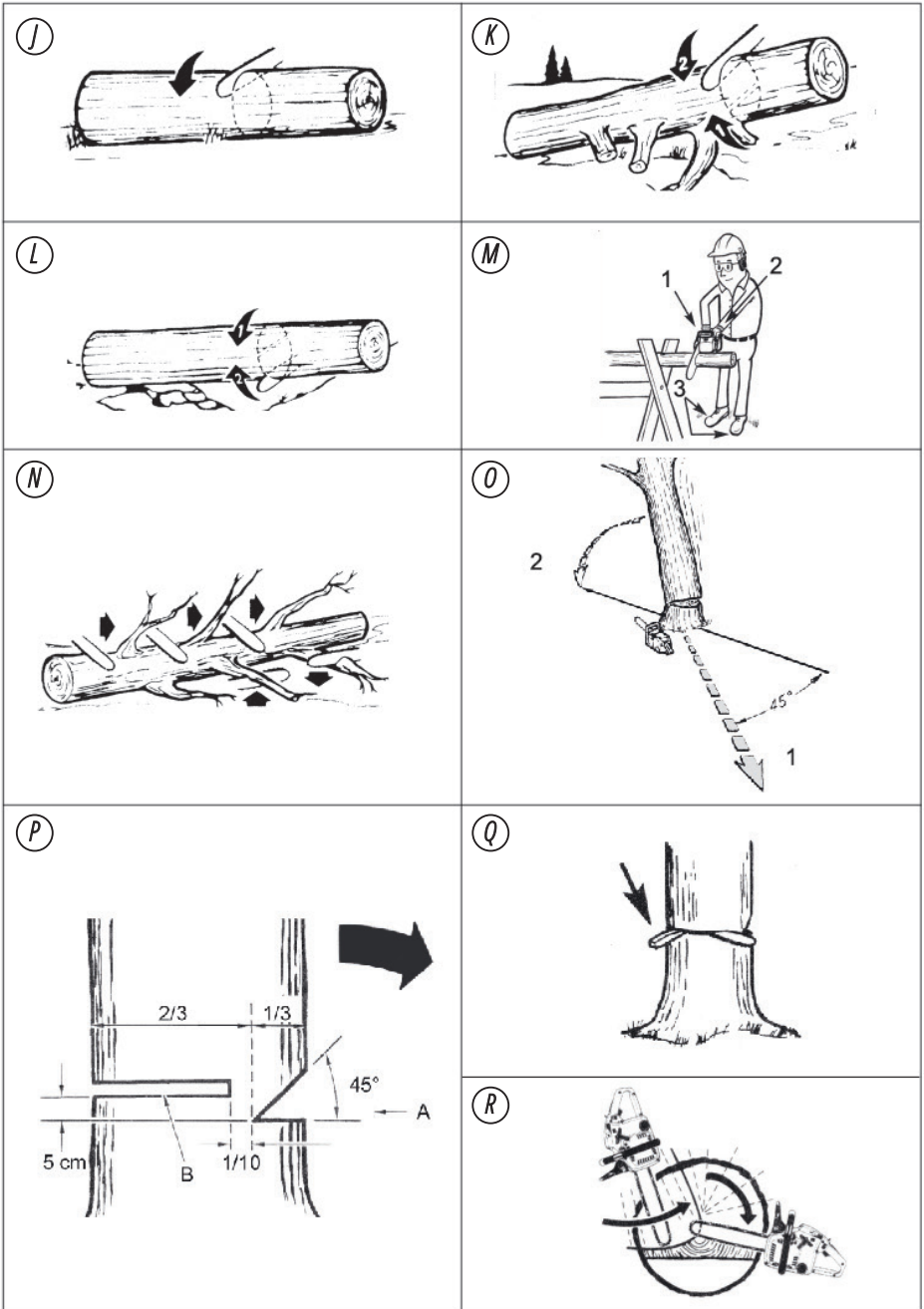



MODEL KS CS1800-14

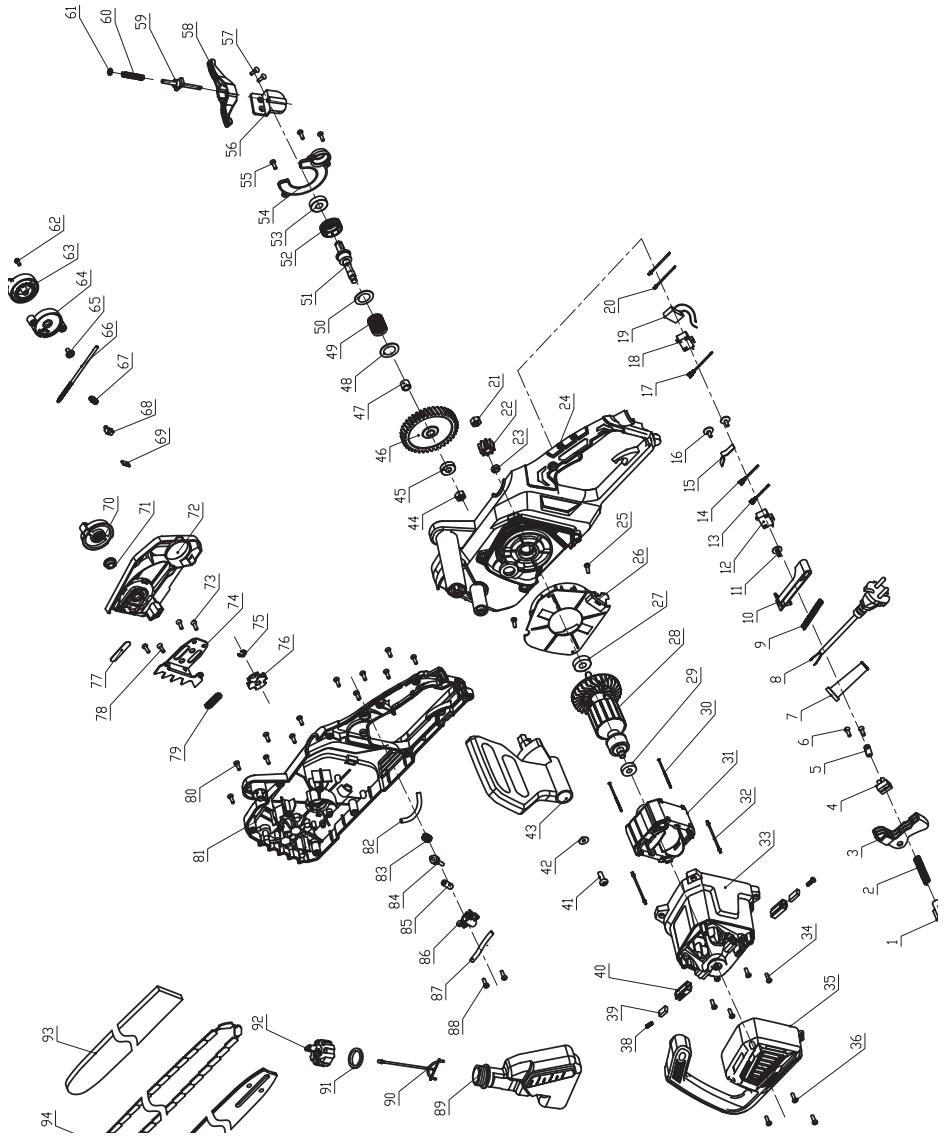



MODEL KS CS2200-16

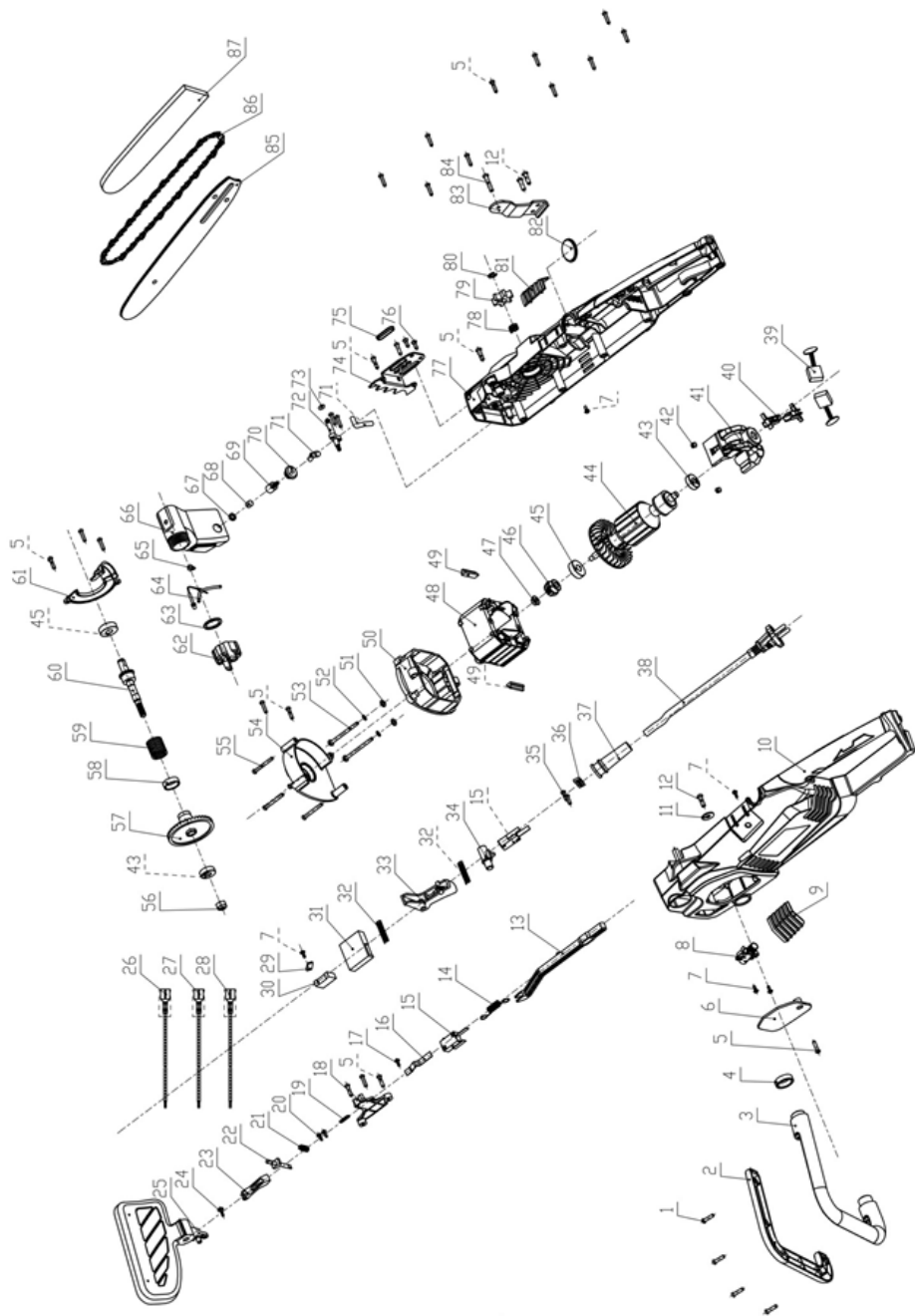



MODEL KS CS2400-18

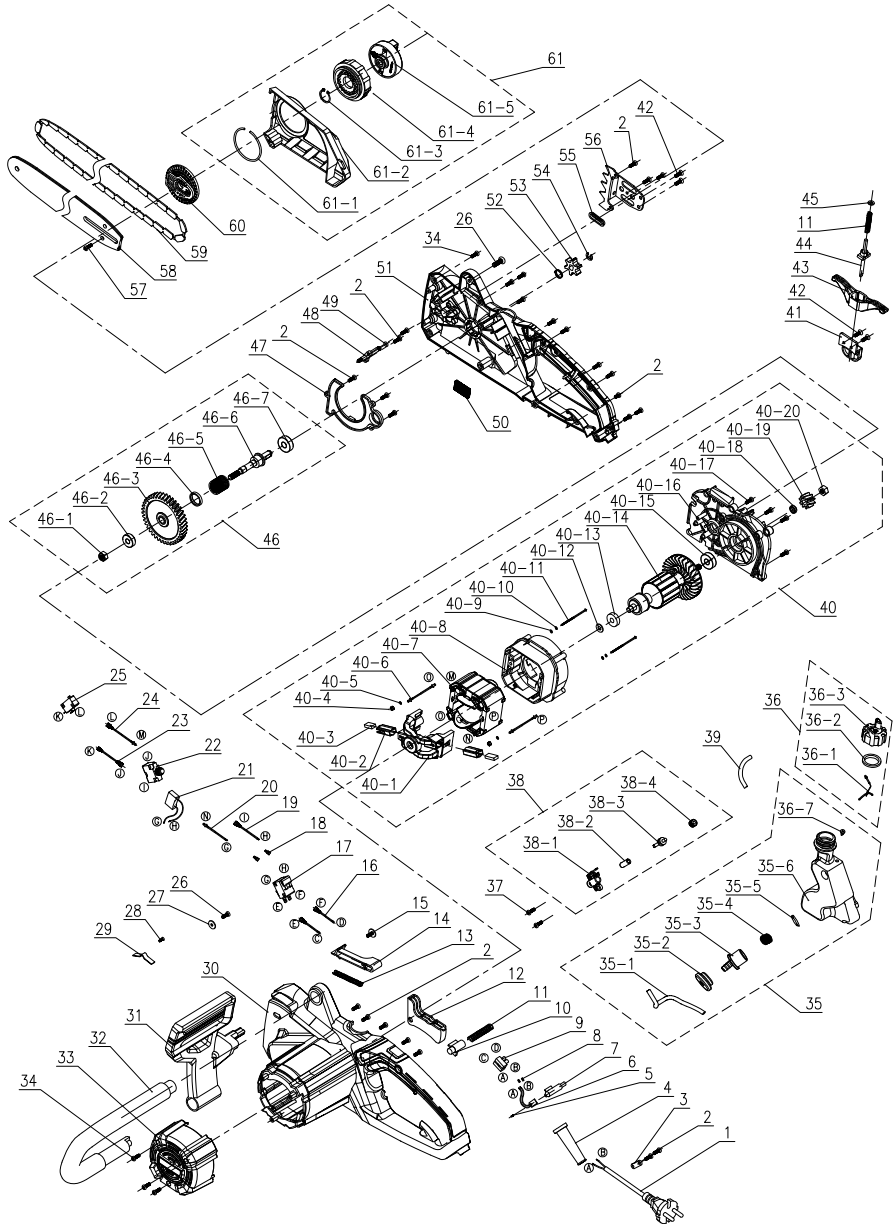



EC Declaration of Conformity

Nr. 172

The following products have been tested by us with the listed standards and found in compliance with the European Community Directive 2014/30/EU relating to electromagnetic compatibility, Directive 2006/42/EC relating to machinery.

Manufacturer: DIMAX INTERNATIONAL GmbH
Address: Flinger Broich 203, 40235 Duesseldorf, Germany
Product: Electric chainsaw "Können & Söhnen"
Type / Model: KS CS1800-14, KS CS 2200-16, KS CS2400-18

The statement is based on a single evaluation of above mentioned products. It does not imply an assessment of the whole production and does not permit the use of the test lab. logo. The manufacturer should ensure that all product in series production are in conformity with the product sample detailed in this report. The applicant should hold the whole technical report at disposal of the competent all the right.

Applied EC Directives: 2014/30/EU Electromagnetic compatibility Directive (EMC)
2006/42/EC Machinery Directive

Applied Standards: EN 55014-1:2017/A11:2020
EN IEC 55014-1:2021
EN 55014-2:2015
EN IEC 55014-2:2021
EN EC 61000-3-2:2019/A1:2021
EN IEC 61000-3-11:2019
EN 62841-1:2015
EN 62841-4-1:2020
AfPS GS 2019:01 PAK
EK9-BE-57(v3):2020
EK9-BE-73(v6):2020
EK9-BE-78(v2):2020
EK9-BE-97(v2):2020
EK9-BE-98(v2):2020

2000/14/EC_2005/88/EC Annex VI

For model KS CS1800-14 Noise measured Lwa = 100 dB (A), guaranteed Lwa = 108 dB (A)
For model KS CS 2200-16 Noise measured Lwa = 109 dB (A), guaranteed Lwa = 112 dB (A)
For model KS CS2400-18 Noise measured Lwa = 107 dB (A), guaranteed Lwa = 112 dB (A)



22

Issued Date: 2024-01-05
Place of issue: Duesseldorf
Director: Fomin P.

P. Fomin

DIMAX

International GmbH
Flinger Broich 203 40235 Düsseldorf
USt-ID DE296177274
koenner-soehnen.com

We DIMAX INTERNATIONAL GmbH hereby declare that specified above conforms covering European Parliament and Council Directives, 2006/42/EC of 17 May 2006 Machinery Directive, Electromagnetic compatibility Directive (EMC) 2014/30/EC of 26 February 2014. The CE mark above can be used under the responsibility of manufacturer. After completion of an EC declaration of Conformity and compliance with all relevant EC directives.

CONTACTS

Deutschland:

DIMAX International GmbH
Flinger Broich 203 -FortunaPark-
40235 Düsseldorf, Deutschland
www.koenner-soehnen.com

Ihre Bestellungen

orders@dimaxgroup.de

Kundendienst, technische Fragen und Unterstützung

support@dimaxgroup.de

Garantie, Reparatur und Service

service@dimaxgroup.de

Sonstiges

info@dimaxgroup.de

Polska:

DIMAX International
Poland Sp.z o.o.

Polska, Warczawska,
306B 05-082 Stare Babice,
info.pl@dimaxgroup.de

Україна:

ТОВ «Техно Трейд КС»,
вул. Електротехнічна 47, 02222,
м. Київ, Україна

sales@ks-power.com.ua
